

YDS-MFH05-OV2736 V1.0

2MP OmniVision OV2736 RGB-IR MIPI Interface M12 Fixed Focus Camera Module



Front View



Back View

Specifications

Camera Module No.	YDS-MFH05-OV2736 V1.0
Resolution	2MP
Image Sensor	OV2736 RGB-IR
Sensor Type	1/4"
Pixel Size	2.0 um x 2.0 um
EFL	1.39 mm
F.NO	2.50
Pixel	1920 x 1080
View Angle	110°(DFOV)
Lens Dimensions	13.40 x 13.40 x 17.60 mm
Module Size	46.00 x 14.00 mm
Module Type	Fixed Focus
Interface	MIPI
Auto Focus VCM Driver IC	None
Lens Type	650nm IR Cut
Operating Temperature	-40°C to +85°C
Mating Connector	FH12-24S-0.5SH



YDS-MFH05-OV2736 V1.0 2MP OmniVision OV2736 RGB-IR MIPI Interface M12 Fixed Focus Camera Module



Top View



Side View



Bottom View

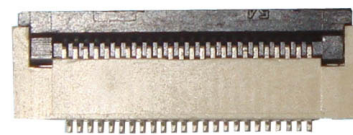

Mating Connector



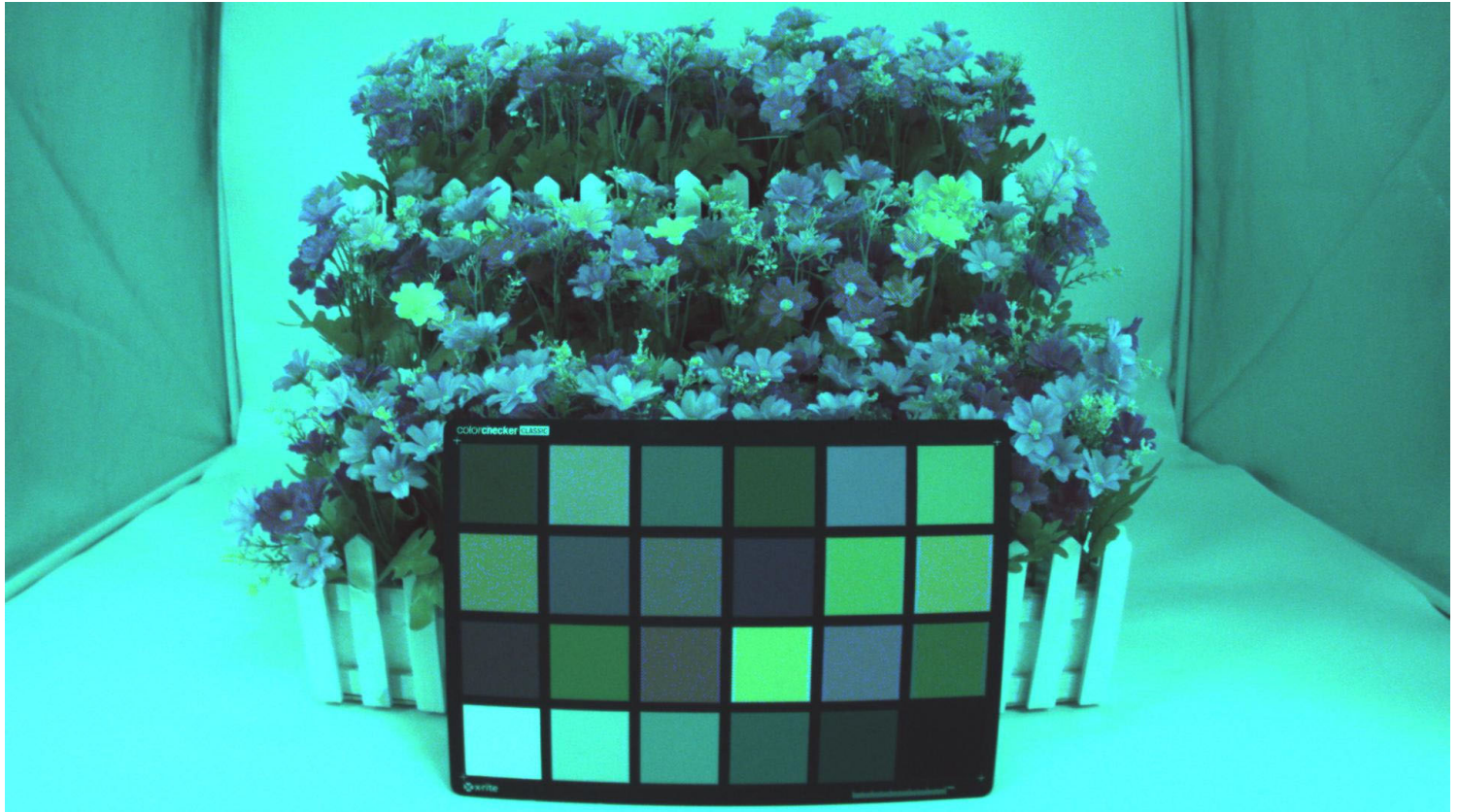
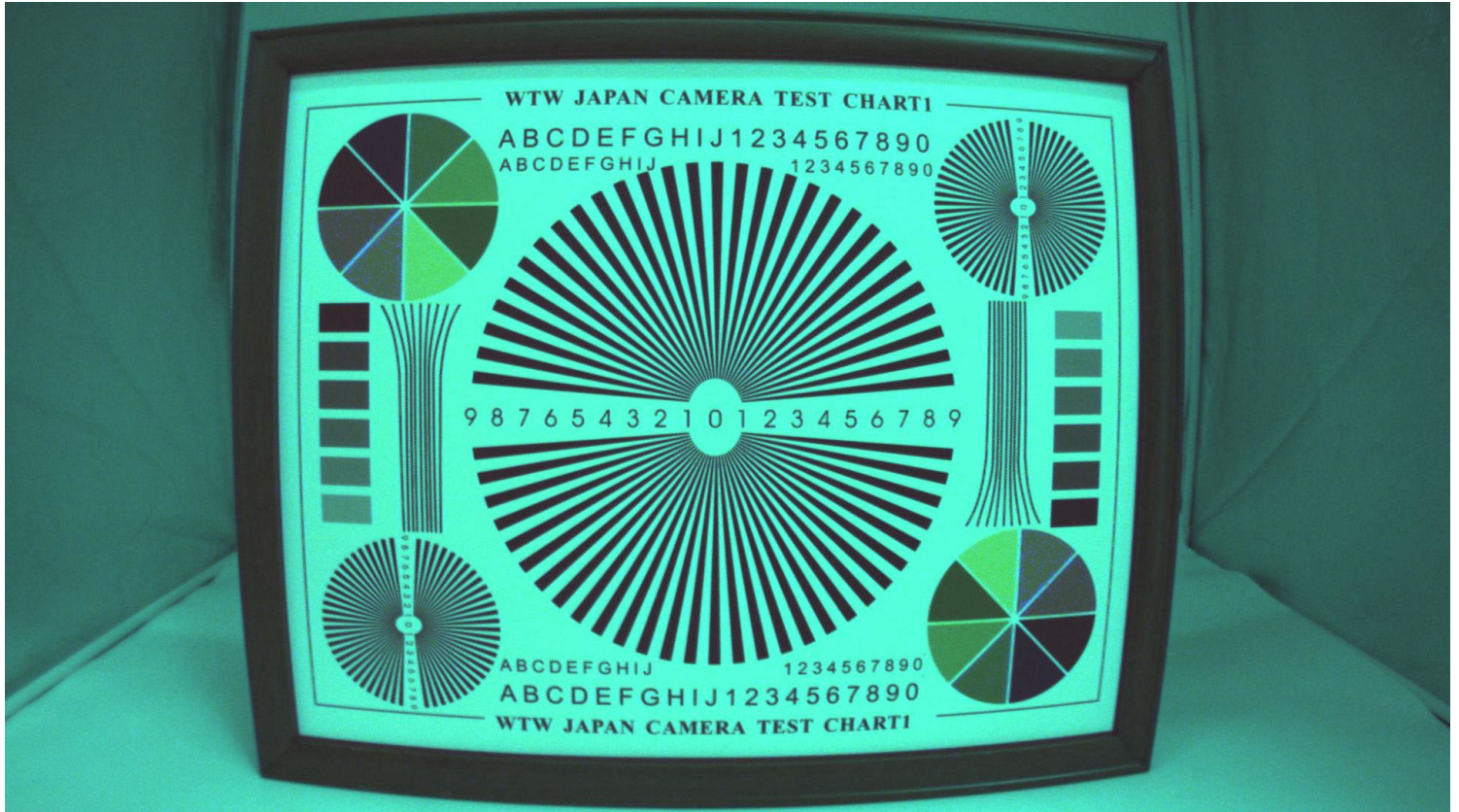

Version	Information	Date
V1.0	First Version	10-23-2023

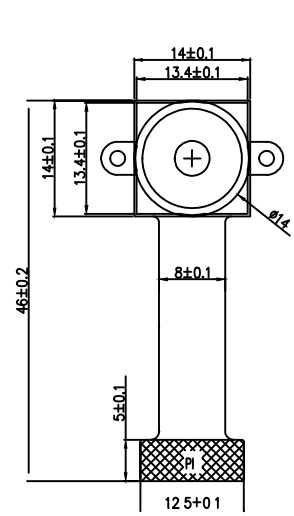
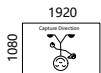

TOP VIEW

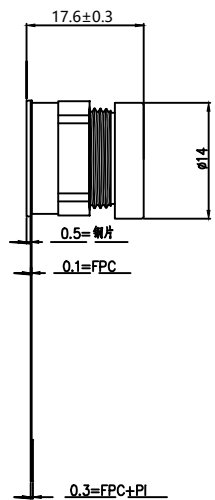

SIDE VIEW

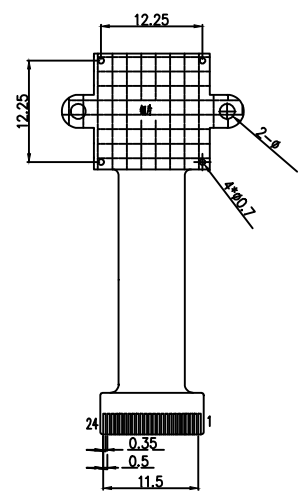

BOTTOM VIEW

Pin	#1	#2	#3	#4	#5	#6	#7	#8	#9	#10	#11	#12	#13	#14	#15
	NC	GND	SDA	AVDD	SCL	RESET	NC	PWDN	NC	DVDD	DOVDD	MCLK	GND	NC	NC
	#16	#17	#18	#19	#20	#21	#22	#23	#24						
	NC	NC	MDP1	MDN1	MDP0	MDN0	GND	MCP	MCN						

Parameters:

1、Sensor specification:

Image Sensor: OV2736
 Pixel: 3.0um*3.0um
 Lens Type: 1/4
 Important Voltage Description:
 AVDD 2.8V ;DVDD 1.2V;DOVDD 1.8V

2、Lens specification:

FOV: 110°(D)
 F/NO.: 2.5
 TV distortion: /
 Focal length: 1.39mm
 Composition: /+IR FILTER
 IR Cut Coating: 650nm±10nm@50%

Designed By	Kevin	Model Name:	MFH05-OV2736 V1.0		
Checked By	Jacky	Projection Type:	Unit: mm	Material: -----	
		Third Angle	Scale: 1:1	Sheet: 1 of 1	Version: 1/0



OV2736 1080p product brief



Low-Power, Compact RGB-Ir Image Sensor for Consumer Applications



available in
a lead-free
package

The OV2736 is a 1/4-inch PureCel® image sensor that uses OmniVision's industry-leading RGB-Ir technology to enable high-end image quality, low power consumption and advanced functionality. These capabilities make the OV2736 suitable for a wide range of battery-powered camera applications, including home security and monitoring, high-end video conferencing, and action or lifestyle cameras.

Using a 4x4 RGB-Ir pixel pattern, the OV2736 eliminates the need for two-camera solutions for devices that require both RGB and infrared imaging.

Using this technology, the sensor delivers unprecedented performance in near-total darkness, capturing high-quality 1080p full high definition (HD) video at 60 frames per second (fps) with high dynamic range (HDR), or 720p HD video at 90 fps.

Rather than a traditional mechanical infrared filter, the OV2736 utilizes dual-band color filters to deliver superior image quality in near-total darkness. The sensor's small optical format and minimal 110 mW power consumption ensure that it is easily integrated into mainstream industrial designs.

Find out more at www.ovt.com.



Applications

- Internet of Things (IoT)
- High-end Video Conferencing
- Security
- Lifestyle Camera
- Home Monitoring

Product Features

- 4x4 RGB-Ir pattern
- programmable controls:
 - gain
 - exposure
 - frame rate
 - image size
 - horizontal mirror
 - vertical flip
 - cropping
 - windowing
- automatic image control functions:
 - black level calibration (BLC)
- serial camera control bus (SCCB)
- digital video port (DVP) parallel output interface
- support for two lane MIPI interface (up to 800 Mbps)
- support for image sizes:
 - 1080p @ 60 fps
 - 720p @ 90 fps
- support for light sensing mode (LSM)
- support for staggered 2 frame HDR
- support for black sun cancellation
- on-chip phase lock loop (PLL)

OV2736



Ordering Information

- OV02736-H46A-1B (RGB-Ir, lead-free) 46-pin CSP

Product Specifications

- active array size: 1920 x 1080
- power supply:
 - core: 1.2V
 - analog: 2.8V
 - I/O: 1.8V
- power requirements:
 - active: 110 mW
- temperature range:
 - operating: -40°C to +85°C junction temperature
 - stable image: 0°C to +60°C junction temperature
- output interfaces: two-lane MIPI / DVP parallel
- output formats: 10/12-bit RAW RGB-Ir
- lens size: 1/4"
- lens chief ray angle: 12° linear
- input clock frequency: 6 - 27 MHz
- scan mode: progressive
- maximum image transfer rate:
 - 1080p: 60 fps
 - 720p: 90 fps
- sensitivity: 12.5 Ke-/Lux-sec
- shutter: rolling shutter
- max S/N ratio: 38.2 dB
- dynamic range: 74.5 dB @ 16x gain
- maximum exposure interval: 1184 x t_{row}
- pixel size: 2 μm x 2 μm
- image area: 3868 μm x 2190 μm
- package dimensions: 5134 μm x 3640 μm

Functional Block Diagram

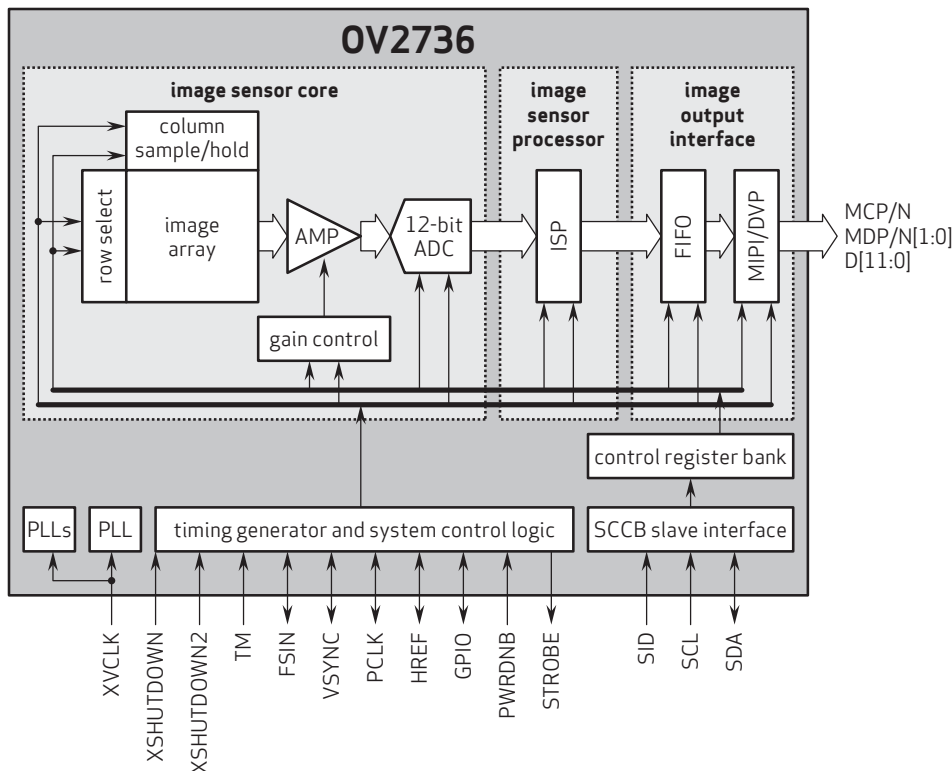

4275 Burton Drive
Santa Clara, CA 95054
USA

Tel: + 1 408 567 3000
Fax: + 1 408 567 3001
www.ovt.com

OmniVision reserves the right to make changes to their products or to discontinue any product or service without further notice. OmniVision, the OmniVision logo and PureCel are registered trademarks of OmniVision Technologies, Inc. All other trademarks are the property of their respective owners.



OmniVision

0.5mm and 1mm Pitch Connectors For FPC/FFC

FH12 Series

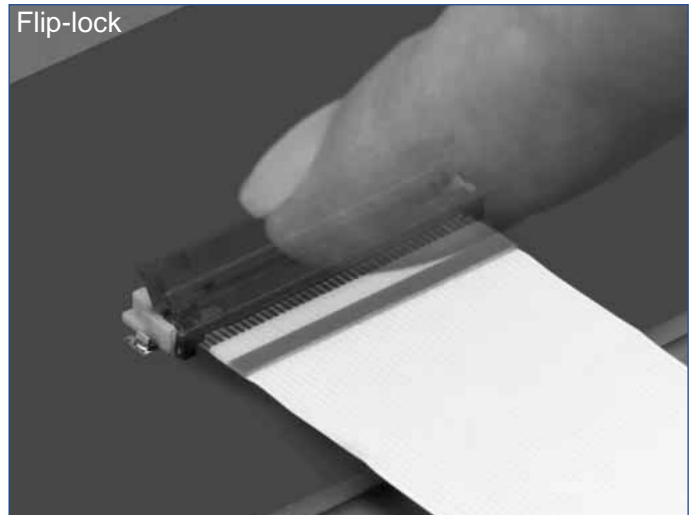
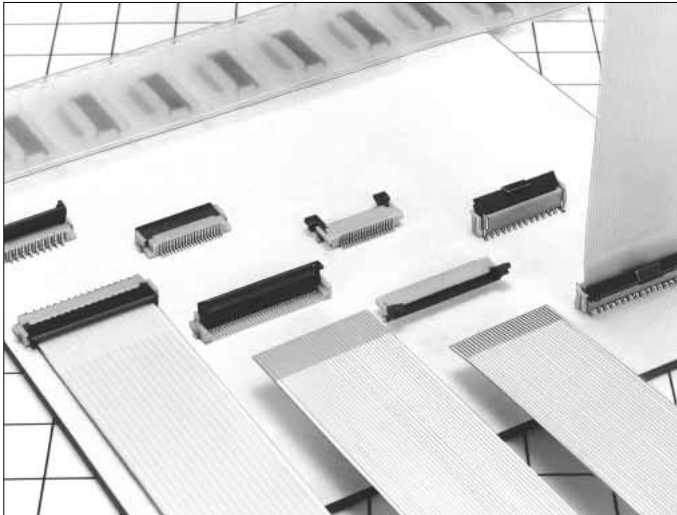

■ Features

1. Ease of Use and Space Savings

Only one finger or 6.9N (Newtons) of force is required to lock Hirose's rotational actuator (flip-lock) as compared to using 2 fingers and 39.2N to close a FFC/FPC connector from our competition.

The Flip-Lock design also allows customers to place 2 or more connectors side by side as there is no need to waste additional board space for a side latch.

2. Strengthened Flip-lock Actuator

The standard Flip-Lock requires only 2.0mm height above the board. A strengthened lock lever is available which only requires an additional 0.4mm.

3. Supports Thin FPC (0.18mm)

Hirose does not require double-sided FPC to have any additional strengthening plate or stiffener and can therefore support a thickness of as little as 0.18mm +/- 0.05.

4. Hirose Ensures Reliability

Hirose's patented half tuning fork contacts maintain the required normal force without relying on the connector housing. With our competitor's conventional products the housing walls support the contact force, which does not provide for long-term reliability.

5. Prevention of Solder Bridge

Excess solder cavity absorbs excessive solder and avoids solder bridging.

6. Three different assembly types

FH12 is offered in Top & Bottom Contact and Vertical Mount and offered in both a 0.5mm contact pitch as well as a 1.0mm contact pitch (bottom contact only).

■ Applications

Notebook computers, printers, PDAs, digital cameras and other compact devices for interconnecting the main circuit board with the LCD, HDD or other device.

Rotating One-touch Mechanism

①

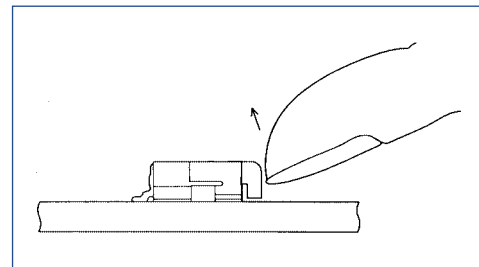

②

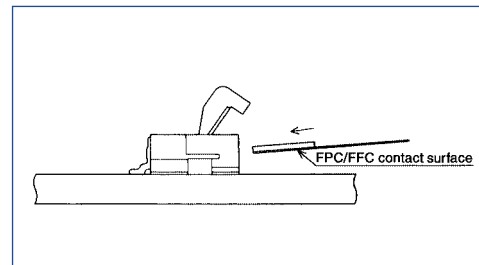

③

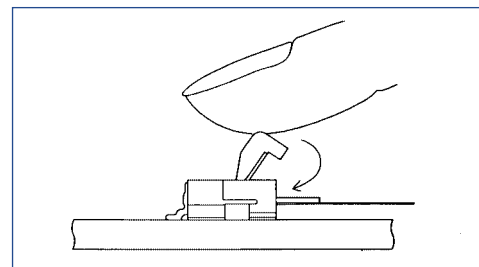

Product Specifications

Rating	Current rating: 0.5A DC(Note 1)	Operating Temperature Range: -40 to +70°C (Note 2)	Storage Temperature Range: -10 to +50°C (Note 3)
	Voltage rating: 50V AC	Operating Humidity Range: Relative humidity, 90% max. (Not dewed)	Storage Humidity Range: Relative humidity, 90% max. (Not dewed)

Applicable FPC	t=0.3±0.05 Gold plated	t=0.18 ± 0.05 for FH12F-*S-0.5SH
----------------	------------------------	----------------------------------

Item	Specification	Conditions
1. Insulation resistance	500M ohms minimum	100V DC
2. Withstanding voltage	No flashover or insulation breakdown.	150V AC/1 minute
3. Contact resistance	50m ohms maximum	1mA
4. Durability (Insertion/withdrawal)	Contact resistance: 50m ohms maximum No damage, cracks, or parts dislocation.	20 cycles
5. Vibration	No electrical discontinuity of 1μs or more Contact resistance: 50m ohms maximum. No damage, cracks, or parts dislocation.	Frequency: 10 to 55 Hz, single amplitude of 0.75 mm, 2 hours in each of the 3 directions.
6. Shock	No electrical discontinuity of 1μs or more Contact resistance: 50m ohms maximum. No damage, cracks, or parts dislocation.	Acceleration of 490 m/s ² , 11 ms duration, sine half-wave waveform, 3 cycles in each of the 3 axis.
7. Humidity(Steady state)	Contact resistance: 50m ohms maximum. Insulation resistance: 50M ohms minimum. No damage, cracks, or parts dislocation.	96 hours at 40°C and humidity of 90% to 95%
8. Temperature Cycle	Contact resistance: 50m ohms maximum. Insulation resistance: 50M ohms minimum. No damage, cracks, or parts dislocation.	Temperature: -40°C → 15 to 35°C → 85°C → 15 to 35°C, Time: 30 → 5 max. → 30 → 5 max.(minutes) 5 cycles
9. Resistance to Soldering heat	No deformation of components affecting performance.	Reflow: At the recommended temperature profile Manual soldering: 350±5°C for 3 seconds

Note 1: When passing the current through all of the contacts, use 70% of the current rating.

Note 2: Includes temperature rise caused by current flow.

Note 3: The term "storage" refers to products stored for long period of time prior to mounting and use. Operating Temperature Range and Humidity range covers nonconducting condition of installed connectors in storage, shipment or during transportation.

Material

Part	Material	Finish	Remarks
Insulator	Polyamide, LCP(60 pos.)	Color : Beige	UL94V-0
Actuator	PPS	Color : Dark brown	
Contact	Phosphor bronze	Gold plated	
Metal Fittings	Brass	Tin plated	

Ordering Information

FH12 **A** - **10** (**4**) - **S** **A** - **0.5** **SH** (**55**)
 ① ② ③ ④ ⑤ ⑥ ⑦ ⑧ ⑨

① Series Name : FH12	⑤ Contact alignment: Single
② Blank : standard type A : Top contact type S : Type with strengthened flip-lock actuator F : Type with 0.18mm FPC End Thickness	⑥ Eccentric direction: Blank : standard type A : Eccentric type
③ Standard type : Number of contacts Eccentric type : Number of contacts in 0.5mm housing	⑦ Contacts Pitch : 0.5mm, 1mm
④ Standard type : Blank Eccentric type : Number of contacts	⑧ Contact type SH : SMT horizontal mounting type SV : SMT vertical mounting type
	⑨ Plating specification (55) : Gold plated

FH12 Series 0.5mm and 1mm Pitch Connectors For FPC/FPC

Series Configuration

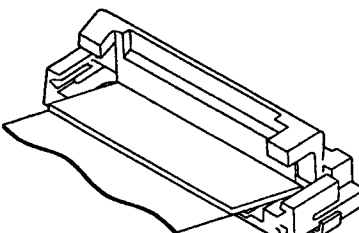
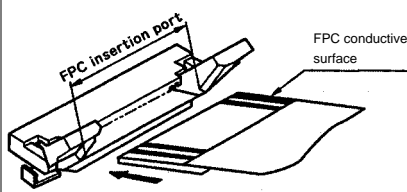
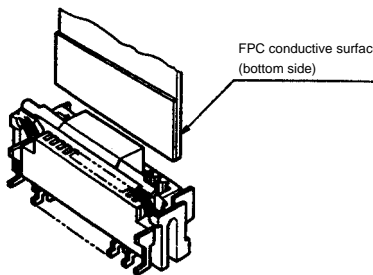
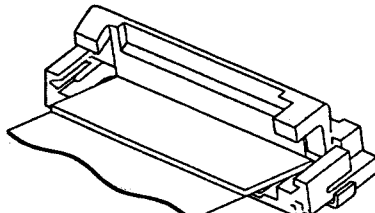
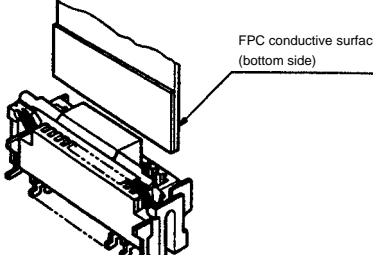
Pitch	Bottom Contact Type	Top Contact Type	Vertical mounting Type
0.5mm	 <p>FH12- ** S-0.5SH P.12 Number of contacts 6, 8, 10, 11, 12, 13, 14, 15, 16, 17, 18, 19, 20, 22, 24, 25, 26, 28, 30, 32, 33, 34, 35, 36, 40, 45, 50, 53</p>		
	Type with Strengthened Lock Lever		
	<p>FH12S- ** S-0.5SH P.13 Number of contacts 30, 40, 45, 50, 53</p>		
	Type with 0.18mm FPC End Thickness		
	<p>FH12F- ** S-0.5SH P.14 Number of contacts 6, 8, 10, 12, 13, 14, 15, 16, 18, 20, 22, 24, 25, 26, 28, 30, 32, 34, 36, 40</p>		
1mm			
	<p>Standard FH12- ** S-1SH P.18 Eccentric FH12- ** (***) SA-1SH Standard Number of contacts 5, 6, 7, 8, 9, 11, 12, 16, 17, 22, 26 Eccentric Number of contacts 4, 6, 8, 10, 11, 14, 19, 24</p>		

0.5mm Pitch Bottom Contact Type

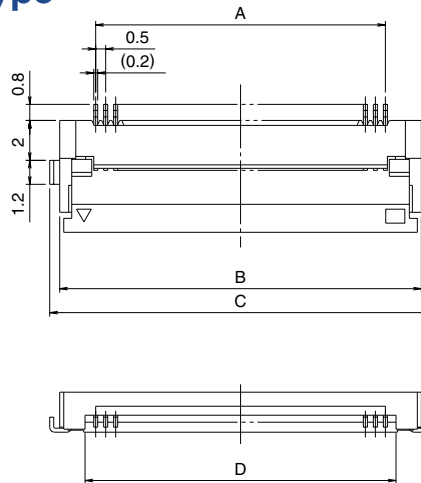

Mated Cross-sectional Diagram

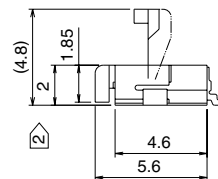
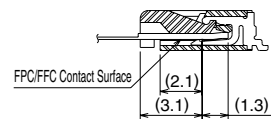

Unit:mm

Part Number	CL No.	Number of Contacts	A	B	C	D	RoHS
FH12- 6S-0.5SH(55)	586-0582-5-55	6	2.5	6.1	7.1	3.57	YES
FH12- 8S-0.5SH(55)	586-0744-5-55	8	3.5	7.1	8.1	4.57	
FH12-10S-0.5SH(55)	586-0522-3-55	10	4.5	8.1	9.1	5.57	
FH12-11S-0.5SH(55)	586-0600-5-55	11	5	8.6	9.6	6.07	
FH12-12S-0.5SH(55)	586-0704-0-55	12	5.5	9.1	10.1	6.57	
FH12-13S-0.5SH(55)	586-0549-0-55	13	6	9.6	10.6	7.07	
FH12-14S-0.5SH(55)	586-0533-0-55	14	6.5	10.1	11.1	7.57	
FH12-15S-0.5SH(55)	586-0523-6-55	15	7	10.6	11.6	8.07	
FH12-16S-0.5SH(55)	586-0531-4-55	16	7.5	11.1	12.1	8.57	
FH12-17S-0.5SH(55)	586-0606-1-55	17	8	11.6	12.6	9.07	
FH12-18S-0.5SH(55)	586-0530-1-55	18	8.5	12.1	13.1	9.57	
FH12-19S-0.5SH(55)	586-0534-2-55	19	9	12.6	13.6	10.07	
FH12-20S-0.5SH(55)	586-0524-9-55	20	9.5	13.1	14.1	10.57	
FH12-22S-0.5SH(55)	586-0532-7-55	22	10.5	14.1	15.1	11.57	
FH12-24S-0.5SH(55)	586-0521-0-55	24	11.5	15.1	16.1	12.57	
FH12-25S-0.5SH(55)	586-0692-3-55	25	12	15.6	16.6	13.07	
FH12-26S-0.5SH(55)	586-0576-2-55	26	12.5	16.1	17.1	13.57	
FH12-28S-0.5SH(55)	586-0612-4-55	28	13.5	17.1	18.1	14.57	
Note ② FH12-30S-0.5SH(55)	586-0525-1-55	30	14.5	18.1	19.1	15.57	
FH12-32S-0.5SH(55)	586-0681-7-55	32	15.5	19.1	20.1	16.57	
FH12-33S-0.5SH(55)	586-0520-8-55	33	16	19.6	20.6	17.07	
FH12-34S-0.5SH(55)	586-0617-8-55	34	16.5	20.1	21.1	17.57	
FH12-35S-0.5SH(55)	586-0740-4-55	35	17.0	20.6	21.6	18.07	
FH12-36S-0.5SH(55)	586-0526-4-55	36	17.5	21.1	22.1	18.57	
Note ② FH12-40S-0.5SH(55)	586-0527-7-55	40	19.5	23.1	24.1	20.57	
Note ② FH12-45S-0.5SH(55)	586-0528-0-55	45	22	25.6	26.6	23.07	
Note ② FH12-50S-0.5SH(55)	586-0529-2-55	50	24.5	28.1	29.1	25.57	
Note ② FH12-53S-0.5SH(55)	586-0595-7-55	53	26	29.6	30.6	27.07	

Note 1 : Embossed tape reel packaging (2,000 pieces/reel).
 Order by number of reels.

Note ② : If there is no problem with the connector height, we recommend the type with the strengthened Flip-lock actuator (FH12S-*S-0.5SH).
 Standard type connector height: 2 mm
 Connector height of type with strengthened Flip-lock actuator: 2.4 mm

Cameras Applications



Automotive Driver Pilot



Live Streaming



Video Conference



Eye Tracker Biometric Detection



Machine Vision



Agricultural Monitor



Night Vision Security



Drone and Sports Eagle Eyes



Interactive Pet Camera



YDS CAMERA MODULE

your best camera partner

Camera Module Pinout Definition Reference Chart

OmniVision	Sony	Samsung	On-Semi	Aptina	Himax	GalaxyCore	PixArt	SmartSens	Sensors
Pin Signal		Description							
DGND	GND								ground for digital circuit
AGND									ground for analog circuit
PCLK	DCK								DVP PCLK output
XCLR	PWDN	XSHUTDOWN	STANDBY						power down active high with internal pull-down resistor
MCLK	XVCLK	XCLK	INCK						system input clock
RESET	RST								reset active low with internal pull-up resistor
NC	NULL								no connect
SDA	SIO_D	SIOD							SCCB data
SCL	SIO_C	SIOC							SCCB input clock
VSYNC	XVS	FSYNC							DVP VSYNC output
HREF	XHS								DVP HREF output
DOVDD									power for I/O circuit
AFVDD									power for VCM circuit
AVDD									power for analog circuit
DVDD									power for digital circuit
STROBE	FSTROBE								strobe output
FSIN									synchronize the VSYNC signal from the other sensor
SID									SCCB last bit ID input
ILPWM									mechanical shutter output indicator
FREX									frame exposure / mechanical shutter
GPIO									general purpose inputs
SLASEL									I2C slave address select
AFEN									CEN chip enable active high on VCM driver IC
MIPI Interface									
MDN0	DN0	MD0N	DATA_N	DMO1N					MIPI 1st data lane negative output
MDP0	DP0	MD0P	DATA_P	DMO1P					MIPI 1st data lane positive output
MDN1	DN1	MD1N	DATA2_N	DMO2N					MIPI 2nd data lane negative output
MDP1	DP1	MD1P	DATA2_P	DMO2P					MIPI 2nd data lane positive output
MDN2	DN2	MD2N	DATA3_N	DMO3N					MIPI 3rd data lane negative output
MDP2	DP2	MD2P	DATA3_P	DMO3P					MIPI 3rd data lane positive output
MDN3	DN3	MD3N	DATA4_N	DMO4N					MIPI 4th data lane negative output
MDP3	DP3	MD3P	DATA4_P	DMO4P					MIPI 4th data lane positive output
MCN	CLKN	CLK_N	DCKN						MIPI clock negative output
MCP	CLKP	MCP	CLK_P	DCKN					MIPI clock positive output
DVP Parallel Interface									
D0	DO0	Y0							DVP data output port 0
D1	DO1	Y1							DVP data output port 1
D2	DO2	Y2							DVP data output port 2
D3	DO3	Y3							DVP data output port 3
D4	DO4	Y4							DVP data output port 4
D5	DO5	Y5							DVP data output port 5
D6	DO6	Y6							DVP data output port 6
D7	DO7	Y7							DVP data output port 7
D8	DO8	Y8							DVP data output port 8
D9	DO9	Y9							DVP data output port 9
D10	DO10	Y10							DVP data output port 10
D11	DO11	Y11							DVP data output port 11

www.YDSCAM.com sales@ydscam.com Phone (WeChat, QQ): (+86) 177 2732 6718

All rights reserved @ YingDeShun Co. Ltd. Specifications subject to change without notice.

Camera Reliability Test

Reliability Inspection Item		Testing Method	Acceptance Criteria	
Category	Item			
Environmental	Storage Temperature	High 60°C 96 Hours	Temperature Chamber	No Abnormal Situation
		Low -20°C 96 Hours	Temperature Chamber	No Abnormal Situation
	Operation Temperature	High 60°C 24 Hours	Temperature Chamber	No Abnormal Situation
		Low -20°C 24 Hours	Temperature Chamber	No Abnormal Situation
	Humidity	60°C 80% 24 Hours	Temperature Chamber	No Abnormal Situation
	Thermal Shock	High 60°C 0.5 Hours Low -20°C 0.5 Hours Cycling in 24 Hours	Temperature Chamber	No Abnormal Situation
Physical	Drop Test (Free Falling)	Without Package 60cm	10 Times on Wood Floor	Electrically Functional
		With Package 60cm	10 Times on Wood Floor	Electrically Functional
	Vibration Test	50Hz X-Axis 2mm 30min	Vibration Table	Electrically Functional
		50Hz Y-Axis 2mm 30min	Vibration Table	Electrically Functional
		50Hz Z-Axis 2mm 30min	Vibration Table	Electrically Functional
	Cable Tensile Strength Test	Loading Weight 4 kg 60 Seconds Cycling in 24 Hours	Tensile Testing Machine	Electrically Functional
Electrical	ESD Test	Contact Discharge 2 KV	ESD Testing Machine	Electrically Functional
		Air Discharge 4 KV	ESD Testing Machine	Electrically Functional
	Aging Test	On/Off 30 Seconds Cycling in 24 Hours	Power Switch	Electrically Functional
	USB Connector	On/Off 250 Times	Plug and Unplug	Electrically Functional



Camera Inspection Standard

Inspection Item		Inspection Method	Standard of Inspection		
Category	Item				
Appearance	FPC/ PCB	Color	The Naked Eye	Major Difference is Not Allowed.	
		Be Torn/Chopped	The Naked Eye	Copper Crack Exposure is Not Allowed.	
		Marking	The Naked Eye	Clear, Recognizable (Within 30cm Distance)	
	Holder	Scratches	The Naked Eye	The Inside Crack Exposure is Not Allowed	
		Gap	The Naked Eye	Meet the Height Standard	
		Screw	The Naked Eye	Make Sure Screws Are Presented (If Any)	
		Damage	The Naked Eye	The Inside Crack Exposure is Not Allowed	
	Lens	Scratch	The Naked Eye	No Effect On Resolution Standard	
		Contamination	The Naked Eye	No Effect On Resolution Standard	
		Oil Film	The Naked Eye	No Effect On Resolution Standard	
		Cover Tape	The Naked Eye	No Issue On Appearance.	
	Function	Image	No Communication	Test Board	Not Allowed
			Bright Pixel	Black Board	Not Allowed In the Image Center
Dark Pixel			White board	Not Allowed In the Image Center	
Blurry			The Naked Eye	Not Allowed	
No Image			The Naked Eye	Not Allowed	
Vertical Line			The Naked Eye	Not Allowed	
Horizontal Line			The Naked Eye	Not Allowed	
Light Leakage			The Naked Eye	Not Allowed	
Blinking Image			The Naked Eye	Not Allowed	
Bruise			Inspection Jig	Not Allowed	
Resolution			Chart	Follows Outgoing Inspection Chart Standard	
Color			The Naked Eye	No Issue	
Noise			The Naked Eye	Not Allowed	
Corner Dark			The Naked Eye	Less Than 100px By 100px	
Color Resolution			The Naked Eye	No Issue	
Dimension	Height	The Naked Eye	Follows Approval Data Sheet		
	Width	The Naked Eye	Follows Approval Data Sheet		
	Length	The Naked Eye	Follows Approval Data Sheet		
	Overall	The Naked Eye	Follows Approval Data Sheet		

YDSCAM Package Solutions

YDS Camera Module



Complete with Lens Protection Film



Tray with Grid and Space



Place Cameras on the Tray

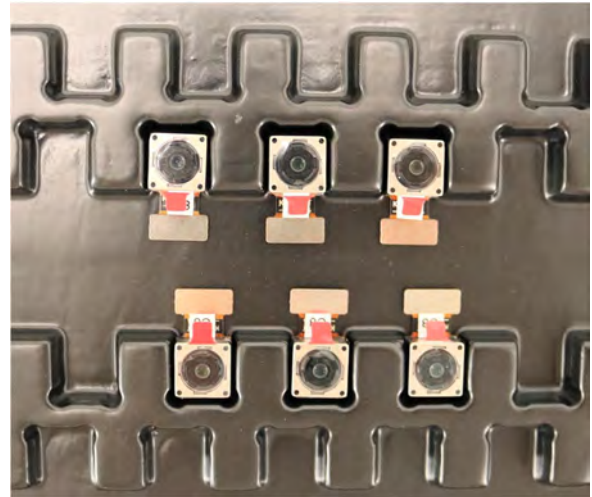

YDSCAM Package Solutions

Full Tray of Cameras

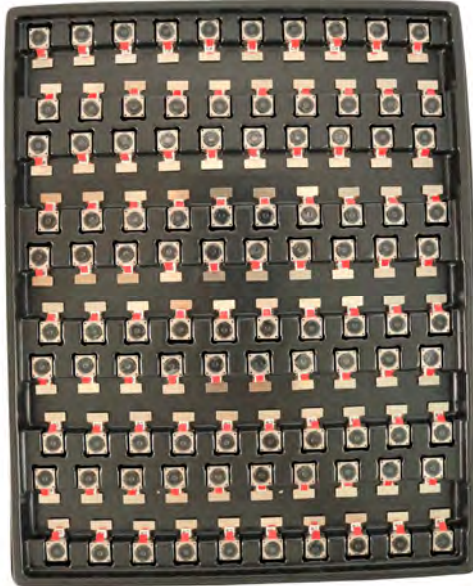

Cover Tray with Lid

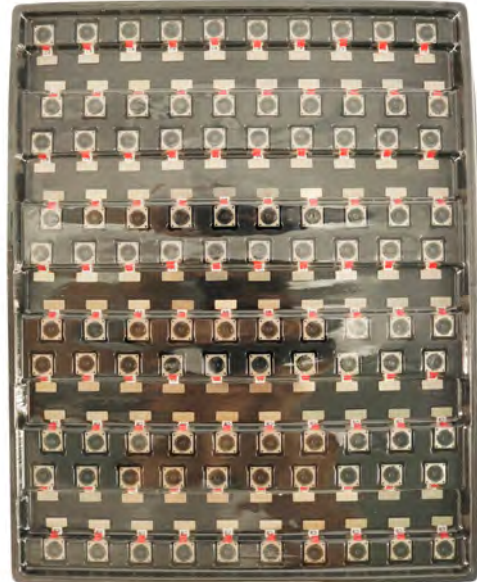

Place Tray into Anti-Static Bag



Vacuum the Anti-Static Bag



YDSCAM Package Solutions

Sealed Vacuum Anti-Static Bag with Labels

1. Model and Description 2. Quantity 3. Manufacturing Date Code 4. Caution



YDSCAM Package Solutions

Place Foam Sheets Between Tray Bags



Foam Sheets are Larger Than Trays



Place Foam Sheets and Trays into Box



Foam Sheets are Tightly Fitting in Box



Seal the Carbon Box



Label the Carbon Shipping Box





YDSCAM Package Solutions

USB Camera Module

Complete with Lens Protection Film



Place Camera Sample into Anti-Static Bag

Place USB Cameras into Tray



Seal the Tray with Anti-Static Bag

Label the Carbon Shipping Box



YDSCAM Package Solutions

Place Camera Sample into Anti-Static Bag



Place Connectors into Anti-Static Bag



Label the Sample Bags



Place Connectors into Reel



Place Samples into the Carbon Box



Place Connectors into the Carbon Box





YDS CAMERA MODULE

your best camera partner

Company YDSCAM

YingDeShun Co. Ltd. (YDS) was established in 2017, a next-generation technology driven manufacturer specialized in research, design, and produce of audio and video products. YDS is occupying 20,000 square feet automated plants with 100 employees of annual throughput 30,000,000 units cameras.

YDS provides OEM, ODM design, contract manufacturing, and builds the camera products. You may provide the requirements to us, even with a hand draft, our sales and engineering work together to meet your needs. We consider ourselves your last-term partner in developing practical and innovative solutions.

Our team covers everything from initial concept development to mass produced product. YDS specializes in customized camera design, raw material, electronic engineering, firmware/software development, product testing, and packing design. Our experienced strategic supply systems offer a robust and dependable manufacturing capacity for orders of various sizes.

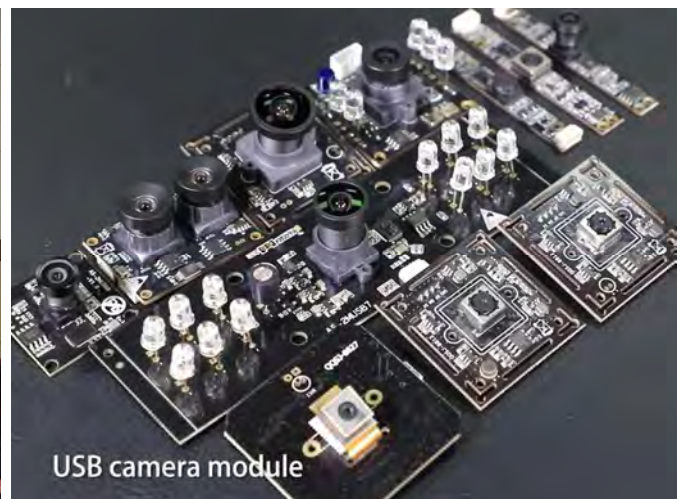

Limited Warranty

YDS provides the following limited warranty if you purchased the Product(s) directly from YDS company or from YDS's website www.YDSCAM.com. Product(s) purchased from other sellers or sources are not covered by this Limited Warranty. YDS guarantees that the Product(s) will be free from defects in materials and workmanship under normal use for a period of one (1) year from the date you receive the product ("Warranty Period").

For all Product(s) that contain or develop material defects in materials or workmanship during the Warranty Period, YDS will, at its sole option, either: (i) repair the Product(s); (ii) replace the Product(s) with a new or refurbished Product(s) (replacement Product(s) being of identical model or functional equivalent); or (iii) provide you a refund of the price you paid for the Product(s).

This Limited Warranty of YDS is solely limited to repair and/or replacement on the terms set forth above. YDS is not reliable or responsible for any subsequent events.



www.YDSCAM.com sales@ydscam.com Phone (WeChat, QQ): (+86) 177 2732 6718

All rights reserved @ YingDeShun Co. Ltd. Specifications subject to change without notice.



YDS CAMERA MODULE

your best camera partner

YDS Strength

Powerful Factory



Professional Service



Promised Delivery



www.YDSCAM.com sales@ydscam.com Phone (WeChat, QQ): (+86) 177 2732 6718

All rights reserved @ YingDeShun Co. Ltd. Specifications subject to change without notice.